

# Instruction Manual

## Screwed End Globe Valve

SS200GL

HIM-037 Version:   C  

Office : 4061 CLOUGH WOODS DR. BATAVIA, OHIO 45103

Fax: 513 752 8267 Tel: 513 752 5600

		Screwed End Globe Valve SS200GL	<b>Version</b>	<b>C</b>
			Date	Nov.26.2012
Document No.	HIM-037			

# CONTENTS

1. Introduction and Safety Information .....	1
1.1 Introduction .....	1
1.2 Safety Information.....	1
2. General Precautions .....	2
2.1 Storage .....	2
2.2 Preparation .....	2
3. Installation and Operation .....	3
3.1 Installation .....	3
3.2 Operation.....	3
4. Maintenance and Repair .....	4
4.1 Inspection and Maintenance .....	4
4.2 Trouble-Shooting.....	5
4.3 Disassembly.....	6
4.4 Reassembly .....	7
5. Quality Assurance and Service .....	8
5.1 Quality Assurance.....	8
5.2 Service.....	8
6. Technical Parameters.....	8
6.1 Specification List.....	8
6.2 Torque.....	9
6.3 Pressure-Temperature Ratings .....	9
7. GLOBE VALVE structure.....	10

		<b>Screwed End Globe Valve SS200GL</b>	<b>Version</b>	<b>C</b>
			Date	Nov.26.2012
Document No.	HIM-037		Page	1

## 1. INTRODUCTION AND SAFETY INFORMATION

### 1.1 INTRODUCTION

This manual has been prepared to serve as a guide to insure continuous satisfactory service and assist in restoring a valve to proper working condition.

It covers 200 WOG screwed ends, weld ends, stainless steel globe valves. The installation, storage, operation, disassembly / reassembly inspection and repair, service problems, maintenance and preventive maintenance covering these globe valves are also included in this manual.

Prior to performing any work on these globe valves, it would be useful to have a general understanding of their construction.

### 1.2 SAFETY INFORMATION

The following general safety notices supplement the specific warnings and cautions appearing elsewhere in this manual. They are recommended precautions that must be understood and applied during operation and maintenance of the equipment covered herein.

- a. Always wear eye shields, gloves and overalls. Wear protective footwear and headgear.
- b. To avoid injury, never attempt disassembly while there are pressures either upstream, or downstream. Even when replacing packing rings, caution is necessary to avoid possible injury.
- c. Do not attempt to disassemble a globe valve while there is pressure in the line. Make sure both upstream and downstream pressures are removed. Disassemble with caution in the event all pressures have not been relieved.
- d. Prior to replacing packing rings remove all pressure from the valve.
- e. To prevent valve distortion, inefficient operation, or early maintenance problems, support piping on each side of the globe valve.
- f. Do not touch surface of globe valve on high temperature.
- g. Globe valves are not to be used with unstable fluids.
- h. If provided, the Locking device on the handle is to avoid improper use of the globe valve by unauthorized people.  
This can be locked with a patch lock.

		<b>Screwed End Globe Valve SS200GL</b>	<b>Version</b>	<b>C</b>
			Date	Nov.26.2012
Document No.	HIM-037		Page	2

## 2. GENERAL PRECAUTIONS

### 2.1 STORAGE

#### 2.1.1 Temporary Storage

If the globe valve is to be stored before installation, the following should be observed.

- a. Keep the globe valve wrapped and protected as shipped from the manufacturer.
- b. Do not remove the plastic bag or protective end covering until the globe valve is ready for installation. This will reduce the possibility of foreign material damaging internal globe valve components.
- c. Globe valve stored outdoors should be positioned such that water dose not accumulate in the valve body.

#### 2.1.2 Long Term Storage

If the globe valves are to be stored more than of one year, they should be prepared in the following manner.

- a. Store the globe valve in a dry area or protect the cavity by applying a preservative coating.
- b. Do not remove the protective end covering. (If any)
- c. Globe valve which will remain in storage for an excessive period of time should have a preservative applied to the external surface.
- d. Do not store the valves outdoors.

### 2.2 PREPARATION

- a. Remove the end protection. (If any)
- b. Prior to shipment from the manufacturer, a preservative may have been applied to the inner body of the globe valve. This preservative maybe removed with a solvent.
- c. The inside of the globe valve should be inspected and blown out with compressed air. As far as possible adjacent piping must be clean and free from debris to prevent early foulness of the globe valve.
- d. To prevent globe valve distortion, inefficient operation or early maintenance problems, support piping on each side of the globe valve.
- e. Install the globe valve according to the flow indicator on the body.

		<p style="text-align: center;">Screwed End Globe Valve SS200GL</p>		<b>Version</b>	<b>C</b>
				Date	Nov.26.2012
Document No.	HIM-037			Page	3

### 3. INSTALLATION AND OPERATION

#### 3.1 INSTALLATION

##### 3.1.1 With Screwed Ends

Taper thread fittings should not be over-tightened. In some applications screwed valves are back welded on site and these valves must be dismantle as per instruction for weld end valves.

##### 3.1.2 With Weld Ends

Clean the weld end as necessary and weld into the line using an approved weld procedure. Make sure the body and pipe material given on the nameplate is compatible with the welding procedure.

#### 3.2 OPERATION

OVC valves provide tight shut off when used under normal conditions and in accordance with pressure/temperature chart. If these globe valves are used in partially open ( throttled ) position seat life may be reduced. This may also cause a chatter noise in the line. Any media which might solidify, crystallize or polymerize should not be allowed to stand in the globe valve cavities unless regular maintenance is provided.

		<b>Screwed End Globe Valve SS200GL</b>	<b>Version</b>	<b>C</b>
			Date	Nov.26.2012
Document No.	HIM-037		Page	4

## 4. MAINTENANCE AND REPAIR

### 4.1 INSPECTION AND MAINTENANCE

A periodic inspection and maintenance schedule should be established for each globe valve. The time frames given for the implementation of these schedules are to be used as a guide only in establishing routine inspection and maintenance schedules. Exact time periods for performing these procedures cannot be provided due to the unknown nature of the service conditions each valve is in.

#### 4.1.1 Periodic Inspection

A periodic inspection should be performed on each unit. The time frame should be adjusted depending on usage and service conditions. An infrequently used unit may have more time between inspections than a globe valve in constant service.

A periodic inspection should include the following:

- a. Examine the valve stem for cleanliness and lubrication. The stem threads should be coated with a clean grease lubricant.
- B. Some valves have a grease fitting in the bonnet. If it is dry, lubricate with a hand grease gun.
- c. Open and close the valve. The actions should be smooth without any binding of the stem through full travel.
- d. If globe valve is in service and under pressure:
  - (1) Examine the body and bonnet for leakage through the gasket. If leakage is found, tighten the bolt nuts evenly in a star pattern until the leakage stops. Do not exceed the maximum torque values. If the leakage persists, see section 4.2 "Troubleshooting".
  - (2) Inspect the exterior of the globe valve for cleanliness. Remove any dirt, grime or oil from the body and bonnet.
- c. After the system is depressurized:
  - Inspect the globe valve internally. Remove any dirt, grime or oil from the globe valve.

#### 4.1.2 Post Inspection

After completion of a periodic inspection, globe valves that are providing satisfactory service require no further disassembly or inspection. Should a globe valve be found which is not performing satisfactorily, see section 4.2 "Trouble-Shooting".

		<b>Screwed End Globe Valve SS200GL</b>		<b>Version</b>	<b>C</b>
				Date	Nov.26.2012
Document No.	HIM-037			Page	5

#### 4.1.3 Maintenance

Other than periodic inspection, no routine maintenance is required. Routine replacement of parts, such as gasket and packing is not usually performed until required. Once in service, it may become apparent that these and other parts require repair or replacement due to usage and service conditions. A maintenance schedule should be developed taking these conditions into consideration. Parts can be replaced during a routine overhaul.

## 4.2 TROUBLE-SHOOTING

The following chart will cover the various problems which are common to most globe valves.

The information provided will aid in isolating and correcting these problems.

PROBLEM	PROBABLE CAUSE	SOLUTION
Leakage through the stem packing	a. Gland nuts are loose. b. Gland is binding against the stem or packing chamber wall. c. Inadequate amount of packing rings. d. Packing is hard and dry. e. Packing was not properly cut and staggered. f. Stem is damaged.	a. Tighten gland bolts. b. Check to insure gland is centered and evenly tightened. c. Install additional packing rings see section 4.3. d. Replace with new packing see section 4.3. e. Replace with new packing see section 4.3. f. Repair or replace as required.
Problems in operating valve	g. Stem binding during travel. h. Stem packing is exerting excessive force on the stem. i. Stem is damaged. j. Internal components may be damaged.	g. Remove dirt and lubricate stem with Grease. h. Check torque on gland nuts. i. Examine stem through full open and close action. Repair or replace as required. j. Disassemble the valve. Inspect and repair as needed.
Bonnet Leakage	k. Bolt nuts are loose. l. Gasket is damaged. m. Body or bonnet faces are damaged.	k. Tighten to values. l. Disassemble and install a new gasket. m. Repair and install a new gasket.
Seat Leakage	n. Valve not properly seated. o. Internal components are damaged or worn.	n. Check to see if valve is tightly closed. o. Inspect internal components and repair as required.

Table 1 - Trouble-Shooting

		<b>Screwed End Globe Valve SS200GL</b>		<b>Version</b>	<b>C</b>
				Date	Nov.26.2012
Document No.	HIM-037			Page	6

#### 4.3 DISASSEMBLY

#### **WARNING**

To prevent injury ensure that all pressure is removed from the valve both upstream and downstream before disassembly.

- a. Check original tightness of valve operation. Remove gland nuts. Lift the gland up the stem clear of the packing chamber.
- b. Remove the existing or defective packing rings with a sharp tool or packing remover. Do not scratch or score the machined surfaces of the stem or packing chamber.
- c. Examine the machined surfaces of the stem and packing chamber. Remove any scratches, scoring or burrs with emery cloth or hand filing. Clean the stem with a solvent soaked rag.
- d. Install new packing. Install rings individually using a split ring spacer, compressing each ring by hand tightening + 1/4 turns on each cap nut.
- e. Compare valve operation to original tightness. If valve operation is considerably tighter than original operating tightness, back off 1/4 turn on each gland nut and recheck tightness.
- f. Several hours after a repacked valve has been returned to service, inspect the packing area to ensure full compression, tight bolting and no leakage. Should leakage occur, tighten gland nuts at 1/4 turn increments until leakage stops.



		<b>Screwed End Globe Valve SS200GL</b>		<b>Version</b>	<b>C</b>
				Date	Nov.26.2012
Document No.	HIM-037			Page	7

#### 4.4 REASSEMBLY

- a. Thoroughly clean the globe valve interior and all components. Remove all oil, grease or other foreign material. Wipe the seating surface of the wedge (or disc) and globe valve seat with a solvent soaked cloth. Clean the body and Bonnet and cap nut.
- b. Install the stem carefully, sliding it through the packing and gland until the threads are engaged with the yoke sleeve. Slowly rotate the stem clockwise until it extends beyond the bonnet.
- c. Place hand wheel in position atop the valve, stem for globe valves. Secure with hand wheel nut.
- d. For globe valves, install the disc and secure it with the bushing or disc nut to the stem.
- e. Install the cap nut and tighten in a star pattern to evenly load the gasket to the torque values listed in Table 2.
- f. Lift the bonnet-stem-wedge assembly up and over the body. Check the location marks on the body, bonnet and wedge. Carefully lower the assembly until the body and bonnet and the location marks meet. Again caution must be used to prevent scoring or scratching of the seating surfaces. Keeping the bonnet stationary, open the valve a few turns to ensure the wedge (or disc) is not touching the seat.
- g. Install the cap nut and tighten in a star pattern to evenly load the gasket to the torque values listed in Table 2.
- h. Open and close the globe valve using the hand wheel. The action should be smooth and regular through full stem travel.

		<b>Screwed End Globe Valve SS200GL</b>	<b>Version</b>	<b>C</b>
			Date	Nov.26.2012
Document No.	HIM-037		Page	8

## 5. QUALITY ASSURANCE AND SERVICE

### 5.1 QUALITY ASSURANCE

OVC's warrants its products to be free from defects in material and workmanship for a period of eighteen (18) months from the date of shipment or twelve (12) months from the date of installation whichever comes first. This warranty is limited to the repair or replacement of the defective item providing that it was handled, installed, used and maintained in accordance with the manufacturer's recommendations and applicable standard industry practices. OVC will not be liable for any additional direct or indirect costs beyond the repair or replacement of the defective item.

This warranty is in lieu of any other warranty expressed or implied.

### 5.2 SERVICE

Manufacturer may provide field installation and debugging where contractually specified.

Manufacturer will follow up the quality of the valve provided and offer service in accordance with customer requirements.

## 6. TECHNICAL PARAMETERS

### 6.1 SPECIFICATION LIST

Type	SS200GL
Technical Parameters	
Nominal pipe size	DN8~ DN50, (1/4" ~ 2")
Nominal pressure	200 WOG
Working temperature	-20°C ~ 200°C, (-4°F ~ 392°F)
Medium	Water, Steam, Oxygen, Vacuum, Chemical, Oil, Food Processing
Pressure test	API 598

Table 2 - Specification List

		<b>Screwed End Globe Valve SS200GL</b>		<b>Version</b>	<b>C</b>
				Date	Nov.26.2012
Document No.	HIM-037			Page	9

## 6.2 TORQUE

NPS	DN	Cap Nut Torque	
		N-m	in-lb
1/4"	8	22	194.72
3/8"	10	22	194.72
1/2"	15	22	194.72
3/4"	20	22	194.72
1"	25	22	194.72
1-1/4"	32	32	283.22
1-1/2"	40	32	283.22
2"	50	32	283.22

Table 3 – Cap Nut Torque

## 6.3 PRESSURE-TEMPERATURE RATINGS

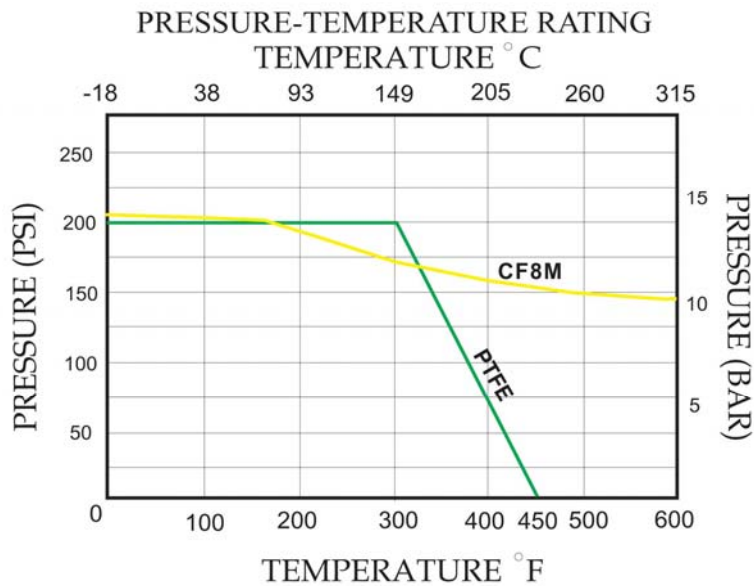

Table 4 - Pressure-Temperature Ratings



# Screwed End Globe Valve SS200GL

**Version**

**C**

Date

Nov.26.2012

Document No.

HIM-037

Page

10

## 7. GLOBE VALVE STRUCTURE

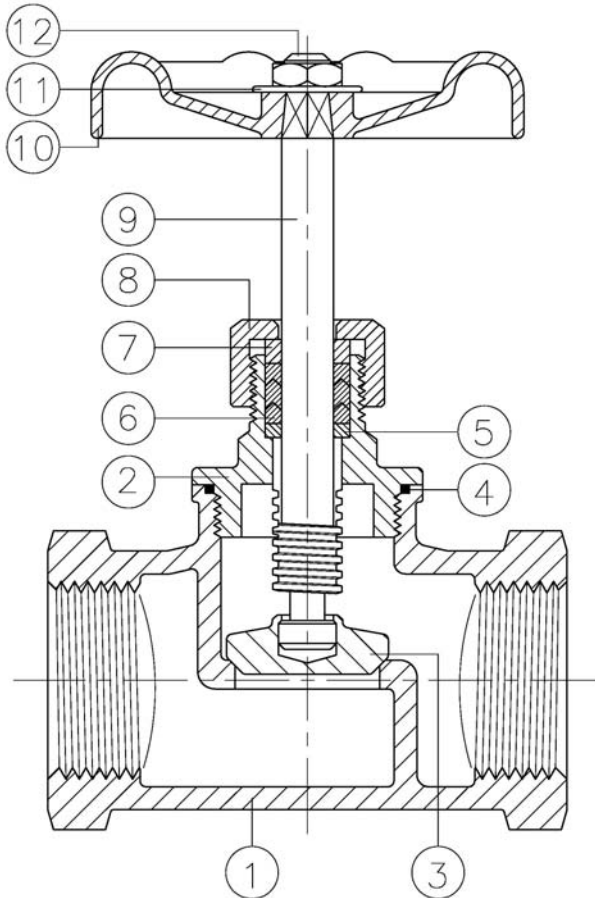

ITEM	PARTS
1	BODY
2	BONNET
3	DISC
4	GASKET
5	WASHER
6	PACKING
7	GLAND
8	CAP NUT
9	STEM
10	HANDLE
11	NAMEPLATE
12	STEM NUT